



HATHORN



OPERATOR'S MANUAL FOR H7 CONTROLLER

For Safe and Effective Operation:

Before operation of your system, it is advised that this manual be read carefully.

CONTENTS

PAGE 4	LIMITED WARRANTY
PAGE 5	LIMITATION OF WARRANTY/ SERVICE/ FREIGHT
PAGE 6	PRODUCT SPECIFICATIONS
PAGE 7-8	FEATURE IDENTIFICATION
PAGE 9-10	KEYPAD & MENU ICONS
PAGE 11	USER INSTRUCTIONS
PAGE 12-13	WI-FI INSTRUCTIONS*
PAGE 14	RECORDING VIDEO / SCREENSHOTS
PAGE 15	PLAYING / DELETING FILES
PAGE 16	INSPECTION PROCEDURE
PAGE 17	LOCATING THE SONDE
PAGE 18	MAINTENANCE
PAGE 19-20	REPAIR FACILITIES IN USA & CANADA

*For Wi-Fi Versions only

LIMITED WARRANTY

This Limited Warranty provides one full year of coverage under our manufacturer's standard new product warranty. Hathorn® Corporation warrants to the original purchaser of our products that the product shall function as designed for a period of one year from the original date of purchase under normal and proper usage. This one year Limited Warranty covers malfunctions resulting from defects in materials or workmanship only. If the product fails to function as designed under normal and proper usage due to defects in materials or workmanship during the period of this Limited Warranty, we will repair, adjust or replace defective parts as Hathorn® Corporation deems appropriate.

This Limited Warranty applies only to Hathorn® Corporation sewer and gas camera systems that are distributed in the United States, Canada and Australia that are purchased from Hathorn® Corporation or a Hathorn® Corporation authorized dealer as identified on our website. The Limited Warranty is not transferable under any circumstances. This Limited Warranty does not apply to Hathorn® Corporation brand products imported and/or sold by unauthorized dealers, distributors, or other sellers.

NOT COVERED BY WARRANTY

This one year Limited Warranty does not cover damage or malfunctions stemming from other than normal and proper usage or from products not meeting the requirements of end users. This Limited Warranty also does not cover the following: (a) intentional or accidental misuse or abuse (including, but not limited to, damage to push rod from excessive force), (b) failure to follow operating or maintenance instructions, (c) repairs by any individual or entity other than an authorized Hathorn® Corporation repair center, (d) use of product components, accessories or consumables not manufactured by Hathorn® Corporation (e) product tampering, (f) droppage, (g) battery leakage if equipped, (h) media cards, (i) excessive light damage to the camera element or (j) damage resulting from being used in extreme environments or due to weather events. Wear and tear are not covered.

Hathorn®'s responsibility under this Limited Warranty is limited to the repair, adjustment or replacement of defective parts as determined by Hathorn® Corporation in its sole discretion. Hathorn® Corporation shall not be held liable for any damages, including, but not limited to direct, indirect, special, or consequential damages arising out of, resulting from, or in any way connected to the use of Hathorn® products. Hathorn® assumes no responsibility for other's use or misuse of its products. Hathorn® Corporation assumes no responsibility for warranties either expressed or implied.

LIMITATION OF LIABILITY

By purchasing a Hathorn® Corporation product, you accept the terms of this limited warranty. You also agree that Hathorn® Corporation shall have no liability to you or any end user for any damages resulting from delay or loss of use of the product due to failure of the product within the warranty period, or otherwise, or in service or repair. Hathorn® shall have no liability for general, special, incidental, or consequential damages arising out of the use or misuse of Hathorn® products.

You also agree that the application and use of a Hathorn® Corporation product is beyond our control and is the sole responsibility of the user. By receiving and using one of Hathorn®'s products, you hereby acknowledge and agree that: you have selected the correct product for your intended use and will examine the product you are purchasing when it arrives to ensure that it meets your needs, you will properly test the product prior to its actual use, you and/or your organization have proper practices in place for the safe use of this equipment and that end users have been trained on its safe operation.

Hathorn® products are not intrinsically safe, not explosion proof, and misuse of the product may cause physical or psychological injury, pain, suffering, illness, disfigurement, temporary or permanent disability, economic or emotional loss or death; and Hathorn® Corporation shall not be held liable for any damages, including but not limited to direct, indirect, special, or consequential damages arising out of, resulting from, or in any way connected to the improper or incorrect use of the product and assumes no responsibility for other's use of the product.

SERVICE

If the product requires service, please contact the Hathorn® service centre, or one of our authorized repair centers. Some service locations are listed in this document (Pages 18 & 19). The remainder can be found on our website.

After requesting a Return Merchandise Authorization (RMA), ship the item PREPAID and INSURED to the appropriate service center. Hathorn® is not responsible for damages or loss incurred in connection with mailing and/or transportation of products.

RETURN FREIGHT

Warranty: Pre-Paid by customer as above, returned by Hathorn® on our account.

Non-Warranty: Freight paid by customer both directions.

NON-WARRANTY CHARGES

Repairs centers will charge direct for non-warranty repairs and may require payment prior to repair.

PRODUCT SPECIFICATIONS

Weight	45lbs
Length x Width x Depth	33" X 19" X 16"
Power	
AC/DC Adapter	12V - 4.1A
Battery	Only Milwaukee® M18 18V or equivalent
Battery Life	~5hrs using 3.0Ah (not recording & sonde off)
Battery Extender	Yes with on-screen battery display
Display	
Type	Impact-resistant LCD
Size	7"
Resolution	1200 x 600 pixels
Brightness	1,000 cd/m2
Footage Counter	Feet or Meters with reset function
Sonde Frequencies	High power 512Hz
Media	
Video	MPEG4 (H.264)
Screenshot	JPEG
Languages	English, Spanish, French
Storage Options	USB, HDD or USB & HDD
Storage Remaining	USB and HDD in Kb
HDD	64Gb SSD [128Gb SSD optional] allowing user >50 hours [100 hours] of video capture
USB	USB 2.0 up 32Gb formatted in FAT format allowing user >25 hours of video capture
Environmental	
Operating Temperature	-10°C to 50°C [14°F to 122°F]
Storage Temperature	-20°C to 60°C [-4°F to 140°F]

FEATURE IDENTIFICATION



Battery Mount
on Back

USB Port

**18V Battery
Cradle and
AC/ DC
Adapter
Power Input**

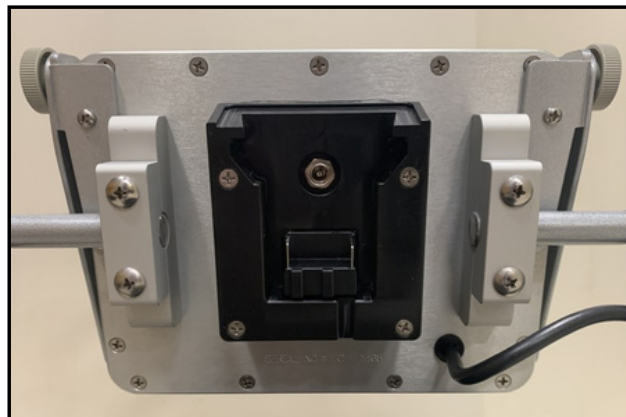



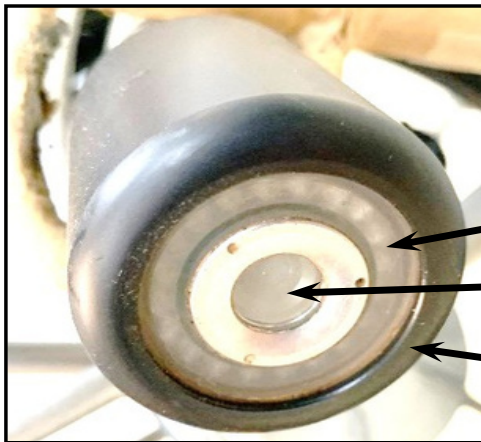
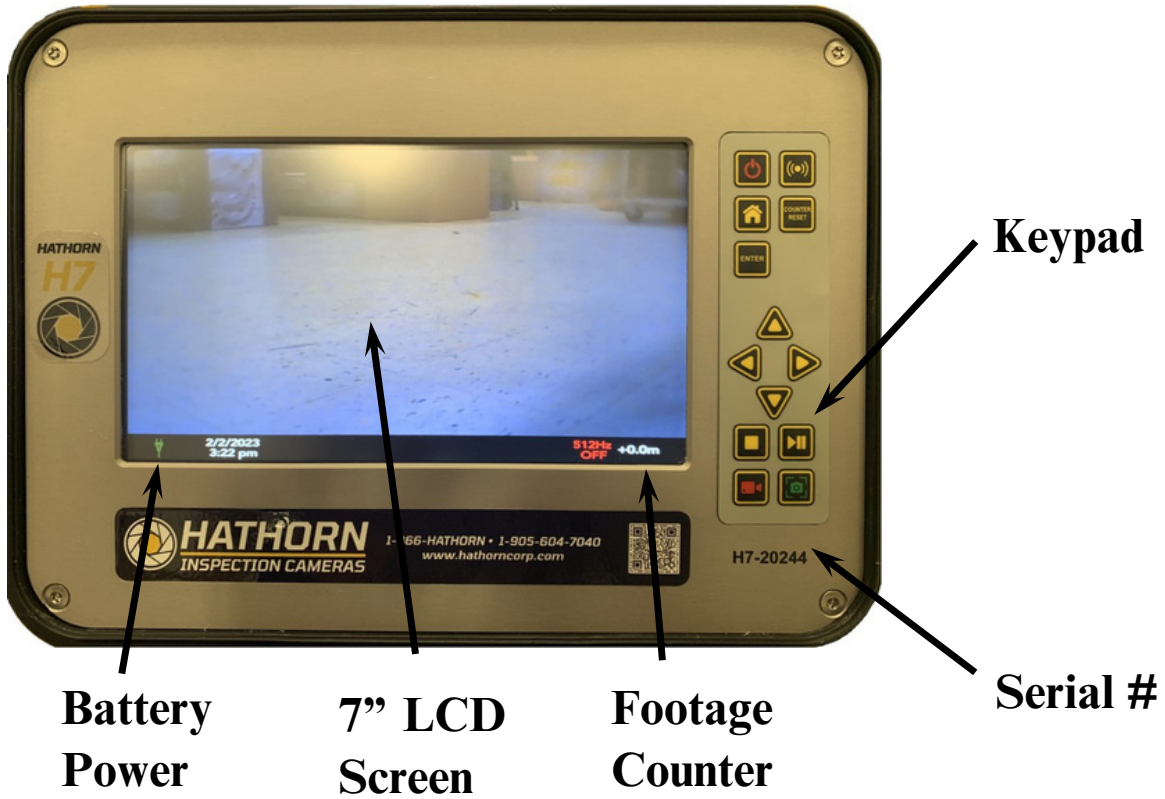





FEATURE IDENTIFICATION



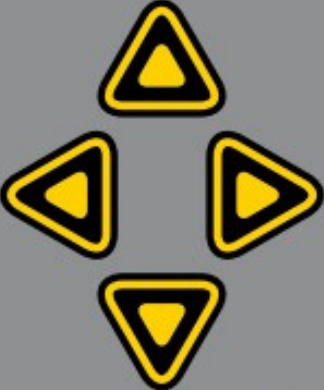

- LED Lights**
- Sapphire Camera Window**
- Plastic Skid/Sleeve**

KEYPAD ICONS

Power On/Off			Sonde On/Off
Menu & Exit			Footage Counter Reset
Enter / Confirm Selection			
Navigation Buttons			
Stop Recording & Playback			Pause Recording & Playback
Record Video			Take Screen shot

MAIN MENU OPTIONS

 REEL SIZE OPTIONS	 CONTROLLER SETTINGS	 FILE STORAGE OPTIONS
---	---	--

INFORMATION BAR ICONS



Battery Monitor



Sonde On/Off & Frequency



Recording Media



Footage (ft. or m)

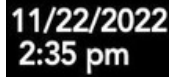

Date & Time

SETTING UP YOUR SYSTEM FOR FIRST USE

Your system comes from the factory set up for use using factory default settings. Should you wish to change any functions or options, press the MENU key, then select Controller Settings.



In the Controller Settings menu you can change:

- Monitor brightness and contrast. For optimal picture, leave brightness at 10 and contrast at 5
- Menu language (English, Spanish and French)
- Sonde frequency of 512Hz or 640Hz
- Footage measurement in Feet or Meters
- File recording location - HDD, USB, or both USB & HDD
- System Time & Date
- Battery extender On/Off which automatically dims the screen when the battery is getting low
- Odometer - Note: This cannot be reset. Permanently records the footage that the monitor has recorded since new
- The home button navigates out of each menu

**NOTE: YOU MUST SELECT THE CORRECT REEL
AND PUSH ROD SIZE TO ENSURE CORRECT
FOOTAGE COUNTER CALIBRATION.
SEE PAGE 11.**

USER INSTRUCTIONS

Turning Your Monitor On

Press the POWER button to turn on the controller. At this point you should see the Hathorn logo on the screen while the system boots up. Boot up takes ~12 seconds.



Note: It is good practice to remove batteries from electronic equipment after use. Failure to do so may result in the batteries being drained over extended periods.

Reel Selection

Your controller comes with two rod thickness / reel options. **You must select the correct reel size to ensure correct footage counter calibration.** To select the correct reel, press the MENU button, then press enter again on the REEL SELECTION icon. You can then confirm which reel you are using. The controller will remember the last reel you selected on restart.



Selecting a Menu Language

In the main menu, you can select the language you prefer to read menu information. Your choices are English, French, or Spanish. To select the preferred language, press the MENU button, then press enter again on the CONTROLLER SETTINGS icon. Press the enter key to highlight the language selection. Choose your language and press enter to confirm.



Turning the Sonde On /Off

On the main screen push the SONDE button to turn the sonde on or off. Sondes are locatable up to ~15ft depth, dependent upon the type of pipe (concrete/steel/cast iron) and the presence of thick concrete, sand, or other utilities.



Footage Counter Reset

Pushing the COUNTER RESET button will reset the footage counter to zero.



WI-FI USER INSTRUCTIONS*

Download the Wi-Fi App

- Turn on the mobile device and enter App Store for either Apple or Android
- Search for the Hathorn-V4 app) latest version
- Install the app software
- Note: You must be running iOS 13 or later for Apple

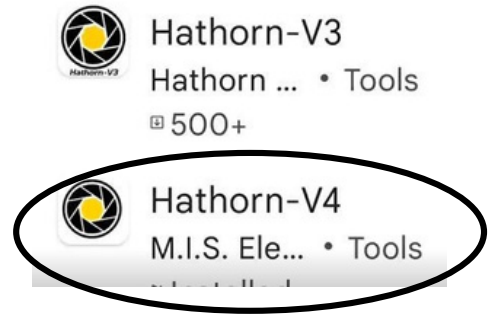

Setting Up the System

Connect DC power plug to the jack on the reel hub using AC/DC adapter or 18V external battery. At this point, you should have lights on the camera.

Access Wi-Fi connections on your device and select the one named “Hathorn #####”. Enter password 12345678. Exit then open the “Hathorn” app and click “CONNECT”. At this point you should have video on your screen.

Note: That this network connection will block all data to the device until the connection is forgotten or another network selected.

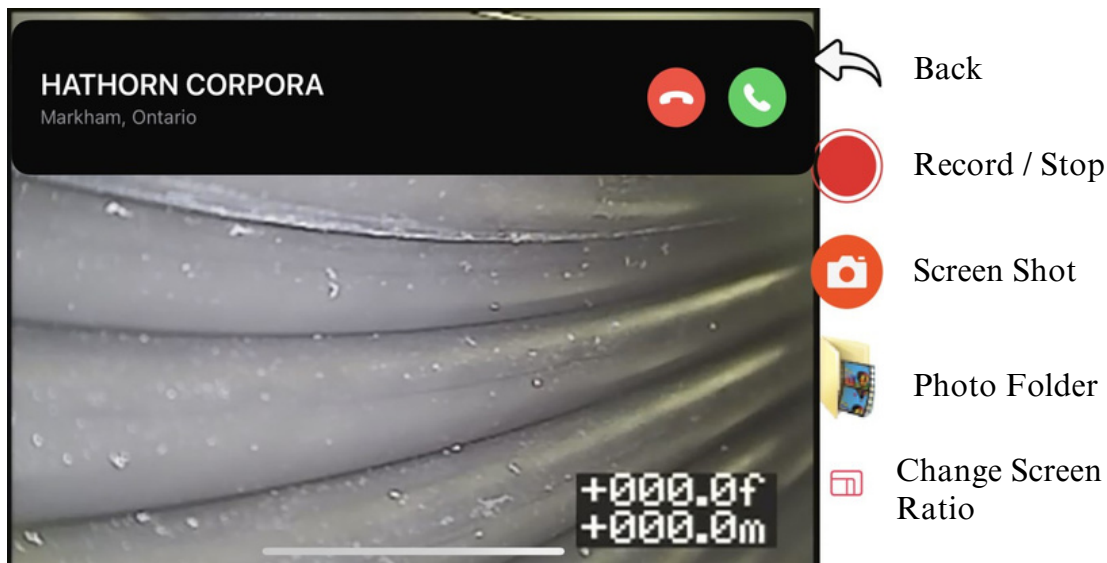

*For Wi-Fi Versions only

WI-FI USER INSTRUCTIONS*

VIDEO VIEWING AND RECORDING

Open the app and click “CONNECT”. If the connection between the camera and the mobile device was successful, the video will begin playing automatically. If it does not, then repeat the Wi-Fi pairing steps. No option exists to pause during recording. If you wish to pause simply stop the recording and start a new one.

All pictures and videos are stored in the photos folder of your device.

NOTE: YOU MUST ALLOW THE APP TO ACCESS TO YOUR PHOTOS FOLDER WHEN INSTALLING THE APP. IF YOU DO NOT THEN VIDEOS WILL NOT BE SAVED.



*For Wi-Fi Versions only

RECORDING VIDEO

Select the media location you wish to record to in the Controller Menu. You can choose USB, HDD or both USB & HDD.

Insert the USB stick into the USB port if you wish to record to USB. All videos are stored in MPEG4 format.

Press the VIDEO RECORDING key on the control pad. You will be notified recording has begun and where files are being saved. Another note will appear in the INFO BAR.



To stop recording, press the STOP key. You will be notified that your file has been saved to media.



To access your recording, press the MENU key and toggle over one space to File Storage Options. Press enter and you will now have access to the HDD and USB.



Note: a new file is created each day recordings/screen shots are made, and that file will have the date of the recordings as its name. All files will be saved in the appropriate dated folder.

Note: Files and folders are always created with the newest on top. The most recent file saved will always be the first file in the first folder.

TAKING A SCREENSHOT

Follow the same instructions as above for video recording, but instead of pressing the VIDEO RECORDING key, press the SCREENSHOT key.

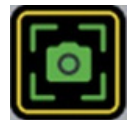

All screenshots are taken in JPEG format and capture whatever is on the screen when the picture is taken. To view photo files, follow the same instructions as above.

Note: The SCREENSHOT FUNCTION also works during the video playback, allowing the user to revisit inspections and take specific screenshots for clients.

PLAYING MEDIA FILES

Press the MENU key, then enter the FILE STORAGE OPTIONS menu.



Select the date on which files were recorded, then highlight the file you wish to play and press the RIGHT ARROW or ENTER key on the keypad or enter key on the keyboard. Your selected file will now be playing (video) or be shown (screen shot).



The screen shot will be shown and the video re-loop until you stop or exit. To exit press the MENU key on the keypad or escape key on the keyboard.

FAST FORWARD / REWIND / PAUSE MEDIA PLAY

When playing a video file, use the LEFT and RIGHT arrow keys on the keypad to fast forward or rewind. Each jump will equal ~5% of the recorded video length.



Pressing the PLAY/PAUSE key on the keypad will allow the user to stop and start the recording for visual inspection.



DELETING

Highlight the file you wish to delete and press the RIGHT ARROW or ENTER key on the keypad. A menu will appear with several options.



You can now DELETE the file in question. Press the MENU key to return to the file.



DELETING FOLDERS

Rather than deleting individual files at a time to free up space, the user can delete entire daily folders by highlighting the specific folder and pressing the STOP button. The user will be prompted to confirm deletion. The user must press the ENTER key to confirm.



Note: Remaining storage space (Kb) on the inserted USB is available at the top of the page while in this menu.

INSPECTION PROCEDURE

Skids or sleeves should ALWAYS be used to protect the camera head. Depending on the size of the pipe you are inspecting, you may need to use a skid, so the camera is centered or off the floor of the line. Care should be taken so the skids do not snag in the line.

Under normal operating situations, the camera is used with a smaller protective sleeve in lines under 4” in diameter, or a larger grooved skid in 4” lines or larger.

1. Slowly push the camera into the pipe and maneuver the camera into position to feed down the pipe, making sure the flex neck does not kink or double back on itself.
2. Push the camera slowly and carefully during the inspection, taking note of the conditions of the pipe for possible hazards that may entangle or damage the camera on entry or retrieval.
3. When maneuvering a corner, care should be taken not to butt the nose of the camera against the sidewall with any force. It would be better to let the camera “work” its way around the corner. If resistance is encountered when turning the corner and there are no visible signs of blockage, turning the push rod or pulling the camera back and forth sometimes helps.
4. Should resistance become extreme, or the camera gets entangled or stuck, slowly push it back and forth to free it. Sometimes, turning the push rod may also help. If the camera is visible, you may be able to free it with your hand or by some other means.
5. Upon completion of the inspection and retrieval of the camera, it may be necessary to ‘manipulate’ the camera around the initial bend (clean out) in the pipe with a pole or other device if required.
6. NEVER use the camera to unclog a drain or clear debris in the pipe. Doing so can cause damage to the camera head or lens.
7. NEVER force the camera down a pipe as this may cause a kinked cable, which will require expensive repairs.
8. NEVER use a pressure washer to clean any part of the system. High pressure water can cause degradation of the electronic parts, causing damage.
9. NEVER unspool all of the rod from a reel. Always leave a few turns of rod on the reel to aid with respooling.

LOCATING THE SONDE SIGNAL (512HZ)

Insert the sonde into the drain and locate it while it is still just in view at the drain or duct entrance. Hold the locator vertically - directly over the sonde with the antenna in line with the sonde. Adjust the locator sensitivity so the bar graph reads between 60% and 80%. Push the sonde along the pipe to the desired area.

1. Approach the peak of the signal, working perpendicular to the pipe.
Move the locator backwards and forwards and stop when the bar graph indicates a Peak.
2. Push the camera 4-6 ft. further, pinpoint, and mark the position. Repeat this pinpointing procedure at similar intervals along the line of the drain or duct until the survey is completed.
3. Most locators will automatically display the depth of a located sonde, provided the locator is correctly oriented and positioned above the sonde.

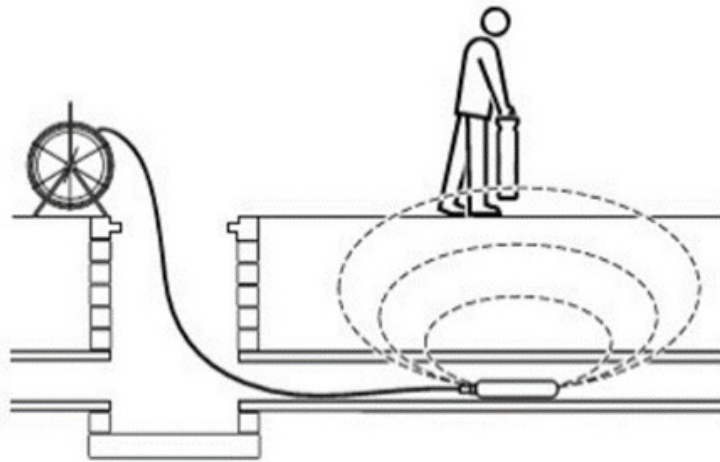

MAINTENANCE

Inspection Camera - After every use, the camera should be cleaned and checked for possible damage. External scuffing of the camera case is normal and should be of no concern. The camera view port is made of sapphire and should be cleaned with a soft, damp cloth. Grease, dirt or scratches will affect the quality of the video and if the lens is badly scratched it should be replaced.

LED Light Replacement - The camera heads use LED lighting and cannot be replaced by the operator. These lights use very little power and unless physically damaged or extreme voltage is applied to them, should last indefinitely. If replacement is necessary, the camera should be returned to the factory.

Reel and Cable Assembly Maintenance - The reel and cable assembly should be kept clean from dirt, slime, grit, etc. When winding the cable back onto the reel after an inspection, it is good practice to use a cloth to wipe off any debris.

WARNING

NEVER USE A POWER WASHER TO CLEAN YOUR INSPECTION EQUIPMENT. PRESSURIZED WATER MAY GET INTO UNSEALED AREAS SUCH AS THE USB BLOCK, REEL HUB ASSEMBLY AND SLIP RING HOUSING CAUSING DAMAGE.

WATER DAMAGE TO ELECTRONIC EQUIPMENT IS NOT COVERED BY YOUR WARRANTY.

REPAIR FACILITIES - USA

Repairs, warranty or otherwise, returned to must be submitted with a “Return Maintenance Authorization.” For “RMAs” please contact:

Hathorn USA

Address: 739 North Wilson Road, Columbus, OH, 43204

Phone: 1-855-863-9226 **FAX:** 1-905-604-3400

Email: usaservice@hathorncorp.com

Website: www.hathorncorp.com

Kaiser Premier USA – Mobile Repairs South West

Address: 6108 Wild Fox Court, Elk Grove, CA 95757

Phone: 1-916-995-2743

Email: eric.montgomery@kaiserpremier.com

Website: www.kaiserpremier.com

Utility Equipment Technology Ltd

Address: 382 Stevens Rd., Rockwall, TX 75032

Phone: 1-972-771-8958 **FAX:** 1-972-772-8195

Email: utilityequipment@gmail.com

Website: utilityequipmenttechnology.com

Minicam

Address: 12600 Newburgh Rd, Livonia, MI 48150

Phone: 1-855-863-9226 **FAX:** 1-905-604-3400

Email: info@minicaminc.com

Website: www.minicaminc.com

Note: For other repair center locations please visit www.hathorncorp.com/find-a-repair-center.

REPAIR FACILITIES - CANADA

Repairs, warranty or otherwise, returned to must be submitted with a “Return Maintenance Authorization.” For “RMAs” please contact:

Hathorn Canada - Ontario, Manitoba & Eastern Canada

Address: 255 Shields Court, Unit C, Markham, ON L3R 8V2

Phone: 1-905-604-7040 **FAX:** 1-905-604-3400

Email: service@hathorncorp.com

Website: www.hathorncorp.com

Pipescope Solutions

Address: 1439 Youville Drive, Ottawa, ON K1C 4M8

Phone: 1-647-991-6735

Email: pipescopeolutions@gmail.com

Access Spec Telecommunications - Quebec

Address: 328 Rue St Paul, Repentigny, QC J5Z 4H9

Phone: 1-450-581-7009

Email: service@accessspec.com

Website: www.accessspec.com

The Drain Camera Shop – British Columbia

Address: Unit 148 11782 River Road, Richmond, BC V6X 1Z7

Phone: 1-250-514-5976

Email: info@thedraincamerashop.com

Website: www.thedraincamerashop.com

FixedRight – Alberta and Saskatchewan

Address: 8812-185 St. NW, Edmonton, ALB T5T 1W5

Phone: 1-780-690-9080

Email: roger@fixedright.ca

Website: www.fixedright.ca

Note: For other repair center locations please visit www.hathorncorp.com/find-a-repair-center.



HATHORN

Hathorn Canada

**255 Shields Court, Unit C
Markham, Ontario, Canada
L3R 8V2**

+1 (866) HATHORN

Hathorn USA

**739 North Wilson Road
Columbus, Ohio, USA**